

Sanova

code SANA2310

Telefon : 0510-48 58 90

E-post: info@sanova.se

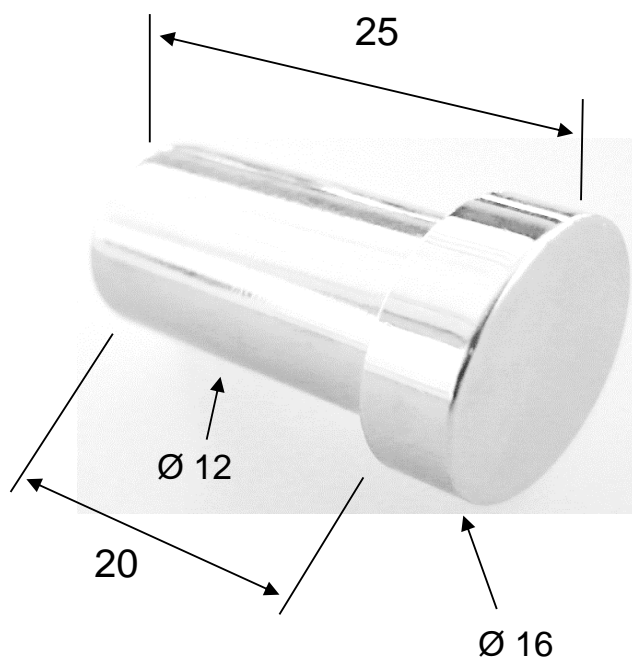

MATERIALS

CHROME PLATED BRASS

CHROME PLATING

UNI EN 248